

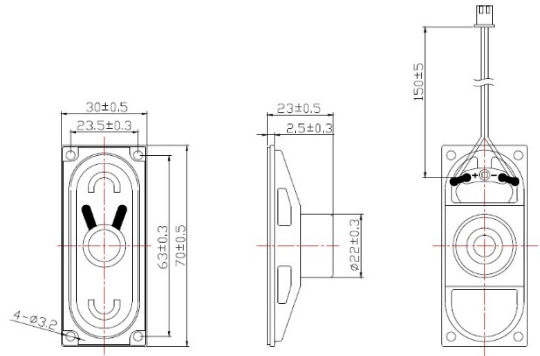

SPEAKER MODEL :L70W30CL

DESCRIPTION SPEAKER



SPEAKER SPECIFICATION

Outer Dimensions	70*30 mm(See attached drawing)		
Rated (Max.)Input	5 W (6W)		
Voice Coil Imp.	4 ± 1.2	Ω	(1000 Hz 1 V)
Lowest Resonance Frequency (fo)	350 ± 20	Hz	(1 V)
Sound Pressure Level	87 ± 2	dB	(0.1 w 0.5 m) at(0.6)(0.8)(1.0)(1.2)KHZ
Frequency Response Deviation	FO Hz ~	20 KHz max	-10 dB
Operating temperature	-20 +50 ± 2	°C	Hours 2 0 ~ 5 0 % R.H.
Load test	White noise at	5 W	48 hours
Weight	35 g		

Other non-stipulated matters are based on CNS4784 4785 4786 based on JIS.C. 5530 5531

FREQUENCY RESPONSE CURVE^(7*18)

