

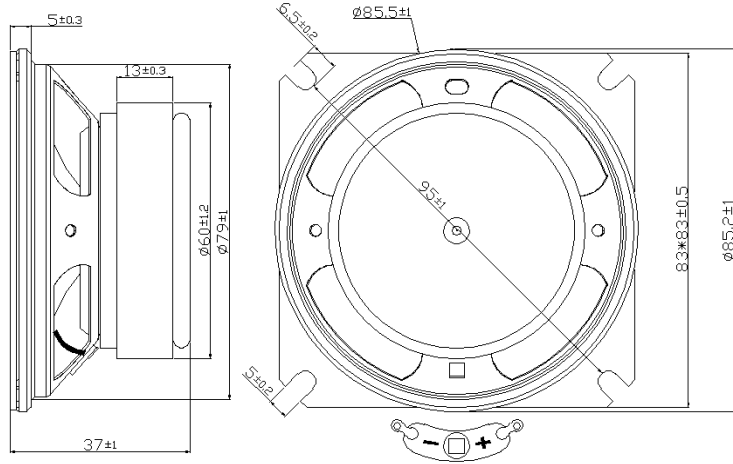

SPEAKER MODEL : 86S-TA

DESCRIPTION SPEAKER



SPEAKERSPECIFICATION

Outer Dimensions	86mm(See attached drawing)
Rated (Max.)Input	10W (15W)
Voice Coil Imp.	8 ± 1.2 Ω (850 Hz 1 V)
Lowest Resonance Frequency (fo)	450 ± 90 Hz (1 V)
Sound Pressure Level	95± 2 dB (1 w 1m) at(0.6)(0.8)(1.0)(1.2)KHZ
Frequency Response Deviation	FO 350 Hz ~ 5 KHz max -10 dB
Operating temperature	-20 +70 ± 2 °C Hours 2 0 ~ 5 0 % R.H.
Load test	White noise at 15W 48 hours
Weight	360 g

Other non-stipulated matters are based on CNS4784 4785 4786 based on JIS.C. 5530 5531

FREQUENCY RESPONSE CURVE^(7*18)

