

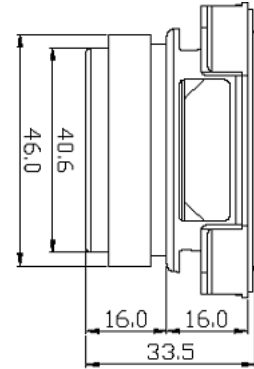

# SPEAKER MODEL : 58SR

## DESCRIPTION SPEAKER

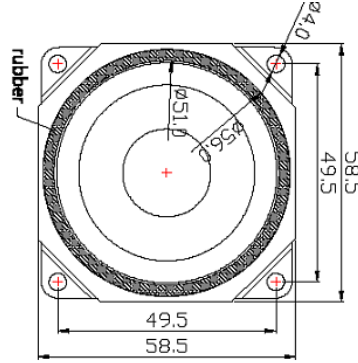

## SPEAKER SPECIFICATION

Outer Dimensions	58mm(See attached drawing)
Rated (Max.)Input	5W ( 6 W)
Voice Coil Imp.	4± 0.6 Ω ( 500 Hz 1 V )
Lowest Resonance Frequency ( fo )	160 ± 32 Hz ( 1 V )
Sound Pressure Level	87± 2 dB ( 1 w 0.5 m ) at(0.6)(0.8)(1.0)(1.2)KHZ
Frequency Response Deviation	FO Hz ~ 20 KHz max -10 dB
Operating temperature	-20 +70 ± 2 °C Hours 20 ~ 50 % R.H.
Load test	White noise at 3 W 48 hours
Weight	157 g

Other non-stipulated matters are based on CNS4784 4785 4786 based on JIS.C. 5530 5531

## FREQUENCY RESPONSE CURVE<sup>(7\*18)</sup>

