

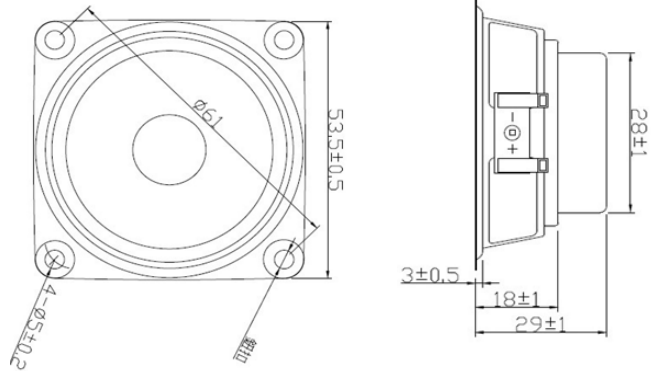

SPEAKER MODEL : 54SR

DESCRIPTION SPEAKER



SPEAKER SPECIFICATION

Outer Dimensions	54mm(See attached drawing)		
Rated (Max.)Input	7W (8 W)		
Voice Coil Imp.	8 ± 1.2	Ω (650 Hz 1 V)	
Lowest Resonance Frequency (fo)	130 ± 26	Hz (1 V)	
Sound Pressure Level	84± 2dB (1 w 0.5 m) at(0.6)(0.8)(1.0)(1.2)KHZ		
Frequency Response Deviation	FO Hz ~ 20 KHz max -10 dB		
Operating temperature	-20 +70 ± 2	°C	Hours 2 0 ~ 5 0 % R.H.
Load test	White noise at 7 W 48 hours		
Weight	70 g		

Other non-stipulated matters are based on CNS4784 4785 4786 based on JIS.C. 5530 5531

FREQUENCY RESPONSE CURVE^(7*18)

