

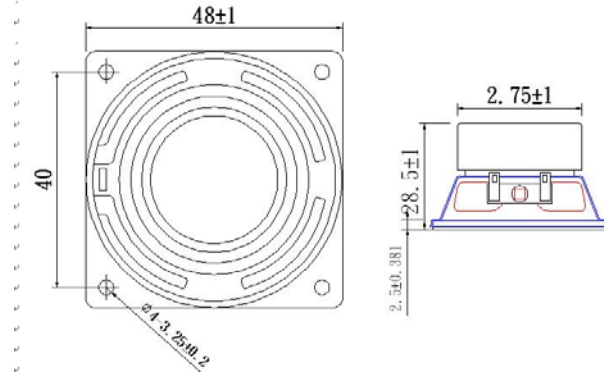

SPEAKER MODEL : 48SS

DESCRIPTION SPEAKER

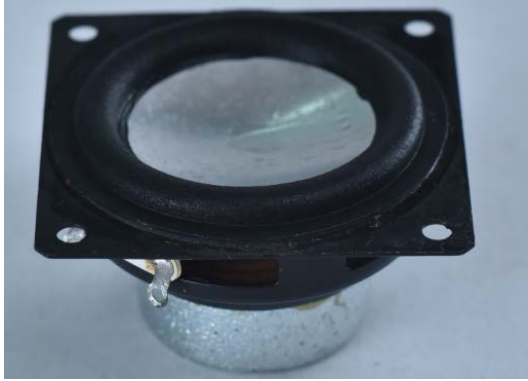

SPEAKER SPECIFICATION

Outer Dimensions	48mm(See attached drawing)
Rated (Max.)Input	10 W (12 W)
Voice Coil Imp.	8 ± 1.2 Ω (600 Hz 1 V)
Lowest Resonance Frequency (fo)	160 ± 32 Hz (1 V)
Sound Pressure Level	79± 32dB (1 w 0.5 m) at(0.6)(0.8)(1.0)(1.2)KHZ
Frequency Response Deviation	FO Hz ~ 20 KHz max -10 dB
Operating temperature	-20 +70 ± 2 °C Hours 20 ~ 50 % R.H.
Load test	White noise at 10 W 48 hours
Weight	250 g

Other non-stipulated matters are based on CNS4784 4785 4786 based on JIS.C. 5530 5531

FREQUENCY RESPONSE CURVE^(7*18)

