

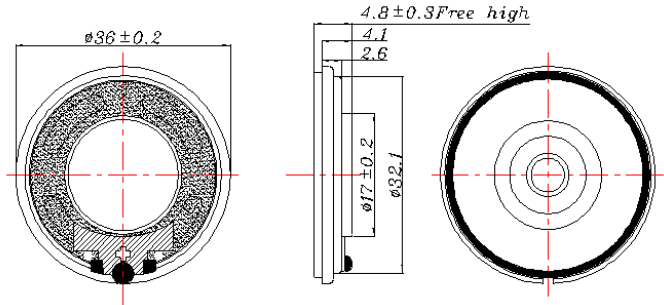

Micro SPEAKER MODEL : 36R-B-AS

DESCRIPTION SPEAKER



SPEAKER SPECIFICATION

Outer Dimensions	36mm(See attached drawing)
Rated (Max.) Input	0.5W (1.0W)
Voice Coil Imp.	8 ± 1.2 Ω (1000 Hz 1 V)
Lowest Resonance Frequency (fo)	550 ± 110 Hz (1 V)
Sound Pressure Level	90 ± 2 dB (0.1w 0.1 m) at(1.0)(1.2)(1.5)(2.0)KHZ
Frequency Response Deviation	FO Hz ~ 20 KHz max -10 dB
Operating temperature	-20 +50 ± 2 °C Hours 20 ~ 50 % R.H.
Load test	White noise at 0.5 W 48 hours
Weight	8.0g

Other non-stipulated matters are based on CNS4784 4785 4786 based on JIS.C. 5530 5531

FREQUENCY RESPONSE CURVE^(7*18)

