

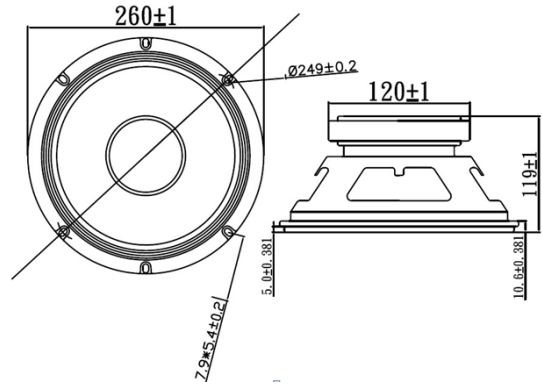

SPEAKER MODEL : 260SR

DESCRIPTION SPEAKER



SPEAKER SPECIFICATION

Outer Dimensions	260mm(See attached drawing)
Rated (Max.)Input	100W (180 W)
Voice Coil Imp.	8 ± 1.2 Ω (200 Hz 1 V)
Lowest Resonance Frequency (fo)	50 ± 10 Hz (1 V)
Sound Pressure Level	92± 2 dB (1 w 0.5 m) at(0.2)(0.25)(0.3)(0.4)KHZ
Frequency Response Deviation	FO Hz ~ 20 KHz max -10 dB
Operating temperature	-20 +70 ± 2 °C Hours 2 0 ~ 5 0 % R.H.
Load test	White noise at 100 W 48 hours
Weight	2500g

Other non-stipulated matters are based on CNS4784 4785 4786 based on JIS.C. 5530 5531

FREQUENCY RESPONSE CURVE^(7*18)

