

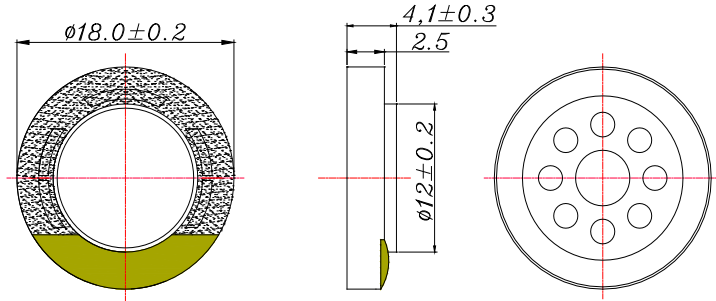

Micro SPEAKER MODEL :18R-AS

DESCRIPTION SPEAKER



SPEAKER SPECIFICATION

Outer Dimensions	18mm(See attached drawing)		
Rated (Max.)Input	0.5W (1.0W)		
Voice Coil Imp.	8 ± 1.2	Ω	(1000 Hz 1 V)
Lowest Resonance Frequency (fo)	850 ± 170	Hz	(1 V)
Sound Pressure Level	89 ± 2	dB	(0.1w 0.1 m) at(1.0)(1.2)(1.5)(2.0)KHZ
Frequency Response Deviation	FO Hz ~	20 KHz max	-10 dB
Operating temperature	-20 +50 ± 2	°C	Hours 20 ~ 50 % R.H.
Load test	White noise at 0.5 W 48 hours		
Weight	5.7 g		

Other non-stipulated matters are based on CNS4784 4785 4786 based on JIS.C. 5530 5531

FREQUENCY RESPONSE CURVE^(7*18)

