

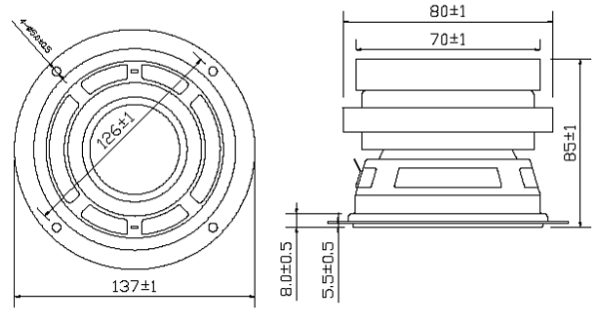

SPEAKER MODEL : 137CR

DESCRIPTION SPEAKER



SPEAKER SPECIFICATION

Outer Dimensions	137mm(See attached drawing)		
Rated (Max.)Input	30W (60 W)		
Voice Coil Imp.	4 ± 0.6	Ω (250 Hz 1 V)	
Lowest Resonance Frequency (fo)	65 ± 13	Hz (1 V)	
Sound Pressure Level	88 ± 2 dB	(1 w 1 m)	at(0.6)(0.8)(1.0)(1.2)KHZ
Frequency Response Deviation	FO Hz ~	20 KHz max	-10 dB
Operating temperature	-20 +70 ± 2	°C	Hours 2 0 ~ 5 0 % R.H.
Load test	White noise at	30 W	48 hours
Weight	918 g		

Other non-stipulated matters are based on CNS4784 4785 4786 based on JIS.C. 5530 5531

FREQUENCY RESPONSE CURVE^(7*18)

