

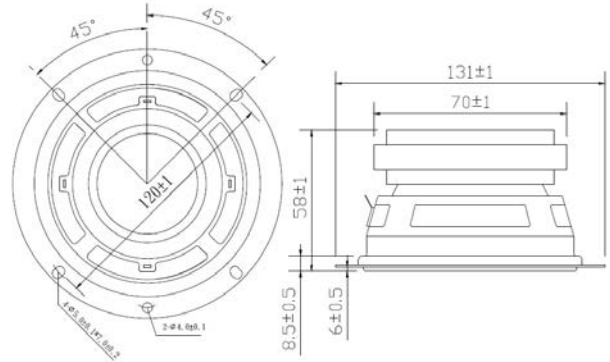

SPEAKER MODEL : 131CR

DESCRIPTION SPEAKER



SPEAKER SPECIFICATION

Outer Dimensions	131mm(See attached drawing)		
Rated (Max.)Input	25W (30 W)		
Voice Coil Imp.	6 ± 0.9 Ω (400 Hz 1 V)		
Lowest Resonance Frequency (fo)	130 ± 26 Hz (1 V)		
Sound Pressure Level	95 ± 2 dB (1 w 1 m) at(0.6)(0.8)(1.0)(1.2)KHZ		
Frequency Response Deviation	FO Hz ~ 20 KHz max -10 dB		
Operating temperature	-20 +70 ± 2 °C	Hours	2 0 ~ 5 0 % R.H.
Load test	White noise at 25 W 48 hours		
Weight	523 g		

Other non-stipulated matters are based on CNS4784 4785 4786 based on JIS.C. 5530 5531

FREQUENCY RESPONSE CURVE^(7*18)

