

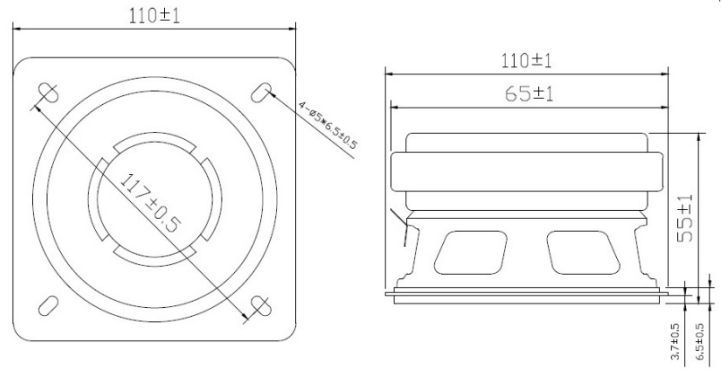

SPEAKER MODEL : 103SR

DESCRIPTION SPEAKER



SPEAKER SPECIFICATION

Outer Dimensions	103mm(See attached drawing)
Rated (Max.) Input	15W (20 W)
Voice Coil Imp.	6 ± 0.9 Ω (300 Hz 1 V)
Lowest Resonance Frequency (fo)	57 ± 12 Hz (1 V)
Sound Pressure Level	90 ± 2 dB (1 w 0.5 m) at(0.6)(0.8)(1.0)(1.2)KHZ
Frequency Response Deviation	FO Hz ~ 7KHz max -10 dB
Operating temperature	-20 +70 ± 2 °C Hours 2 0 ~ 5 0 % R.H.
Load test	White noise at 15 W 48 hours
Weight	405 g

Other non-stipulated matters are based on CNS4784 4785 4786 based on JIS.C. 5530 5531

FREQUENCY RESPONSE CURVE^(7*18)

