

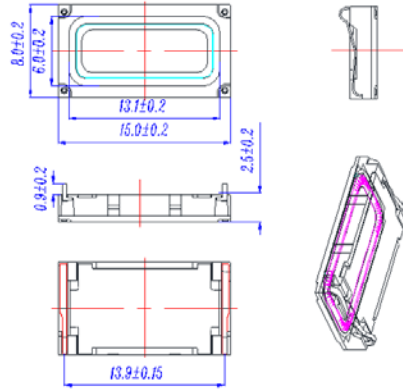

Micro SPEAKER MODEL : 0815L-A-AS

DESCRIPTION SPEAKER



SPEAKER SPECIFICATION

Outer Dimensions	8*15 mm(See attached drawing)		
Rated (Max.)Input	0.5W (0.8W) in 1cc box		
Voice Coil Imp.	8 ± 1.2	Ω	(1000 Hz 1 V)
Lowest Resonance Frequency (fo)	700 ± 140	Hz	(1 V)
Sound Pressure Level	83 ± 2	dB	(0.1 w 0.1 m) at(1.0)(1.2)(1.5)(2.0)KHZ
Frequency Response Deviation	FO Hz ~ 20 KHz max -10 dB		
Operating temperature	-20 +50 ± 2	°C	Hours 2 0 ~ 5 0 % R.H.
Load test	White noise at 1.0 W 48 hours		
Weight	10.6 g		

Other non-stipulated matters are based on CNS4784 4785 4786 based on JIS.C. 5530 5531

FREQUENCY RESPONSE CURVE^(7*18)

